

LOTO

STATIONS

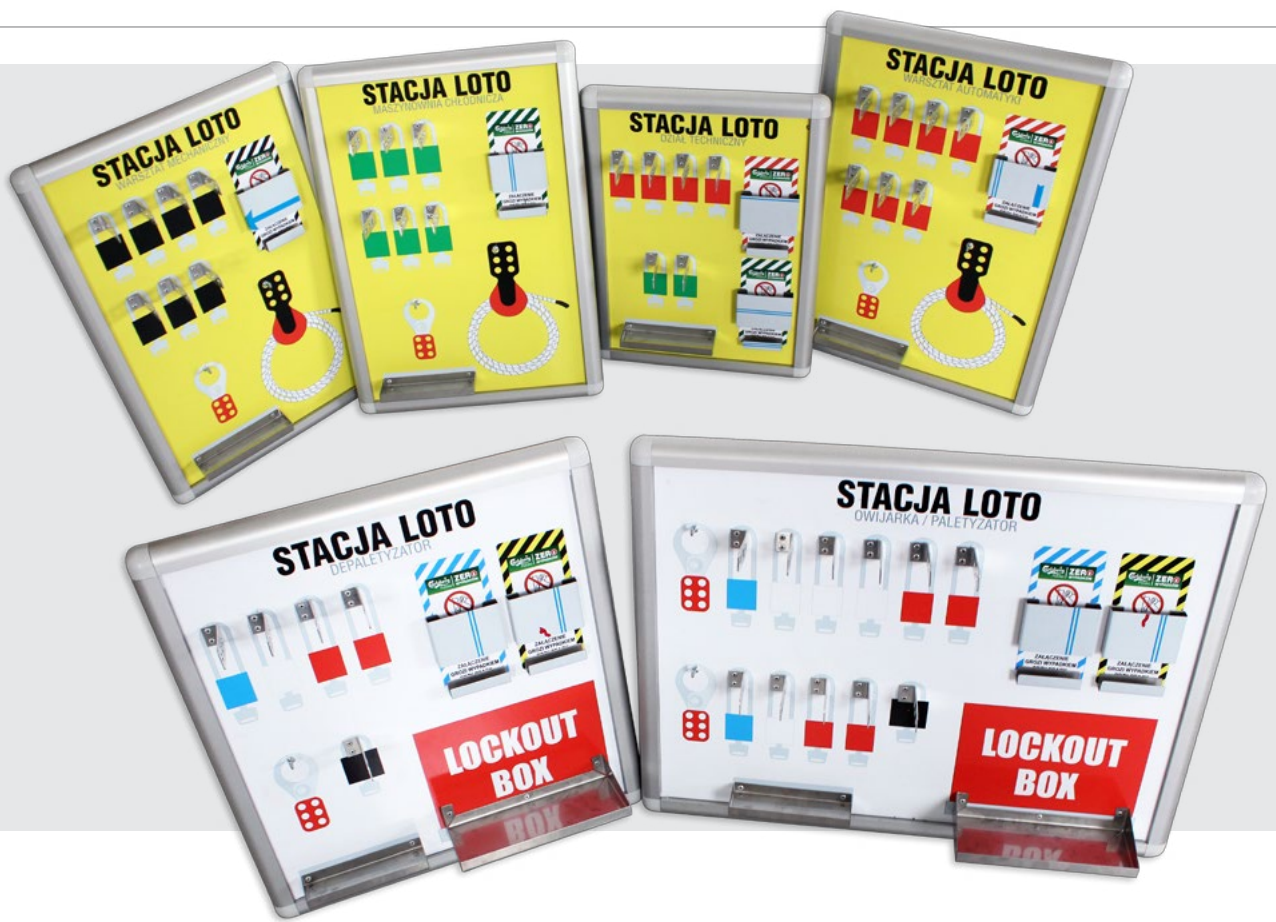

ELMETRAL
LABELLING AND SIGNAGE



LOTO Boards

Our shadow boards are an excellent solution when organising the LOTO system within a company.

- Ability to freely organise the shadows of lockout devices, safety locks, tags (hangers) and other tools
- Wide range of accessories
- Practically unlimited choice of equipment shadows and board dimensions
- Washable, easy to clean surface
- Simple installation – we will install the exact mounting elements you require
- Any background colour (yellow and white as standard) and shadow colour

Standard dimensions	
Height H (mm)	Width W (mm)
400 mm 250 mm	250 mm 400 mm
800 mm 600 mm	600 mm 800 mm
1000 mm 700 mm	700 mm 1000 mm

Other to order

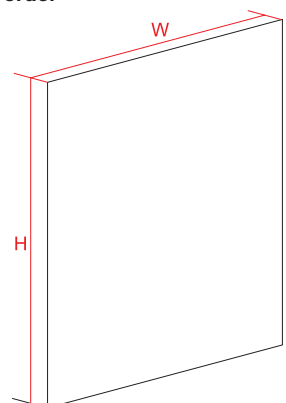

ASK ABOUT
PRODUCT



BASIC ELEMENTS OF EQUIPMENT

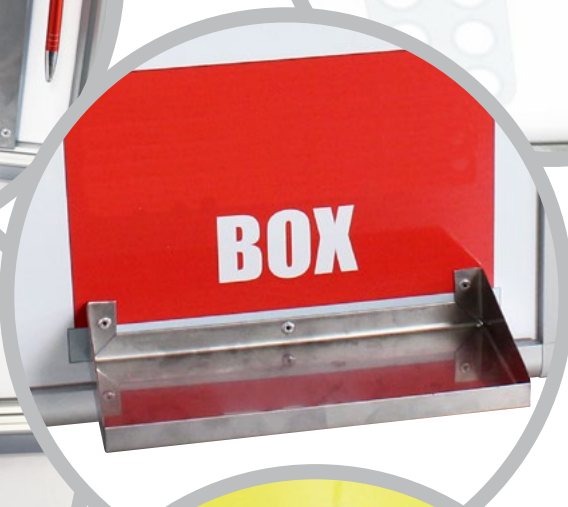

- Metal and plastic hooks
- Angle bracket for padlocks (1-3 padlocks per bracket)
- Document boards with a clamping mechanism
- Mounting of pens and markers
- Pockets for tags
- Screw-on shelves

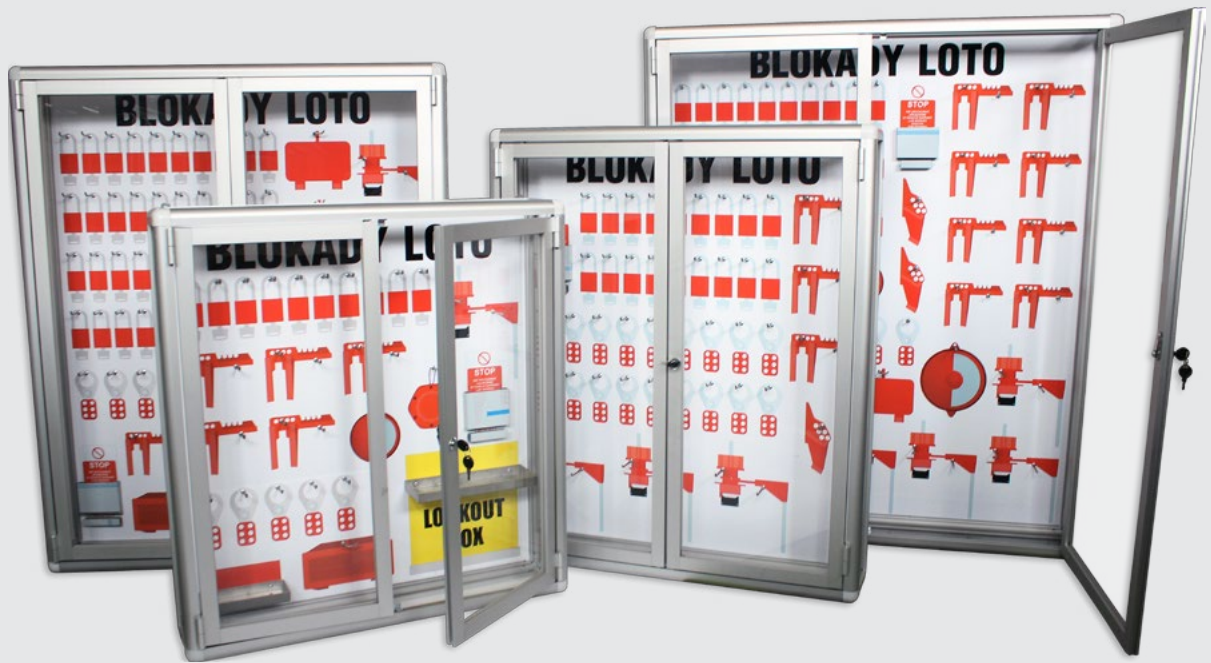

LOTO Cabinets

LOTO cabinets are ideal for areas that require lockout / protection of tools, padlocks and lockout devices.

- Durable, yet lightweight polycarbonate
- The doors can be locked with a key or bolt
- Ability to freely organise the shadows of lockout devices, safety locks, tags (hangers) and other tools
- Wide range of accessories
- Practically unlimited choice of accessories and board dimensions
- Washable, easy to clean surface
- Simple installation – we will install the exact mounting elements you require
- Any background colour (yellow and white as standard) and shadow colour
- Prevents excessive accumulation of dust.

Standard dimensions		
Height H (mm)	Width W (mm)	Depth
400 mm	250 mm	150 mm
800 mm	600 mm	150 mm
1000 mm	700 mm	150 mm

Other to order

Minimum depth: 10 cm

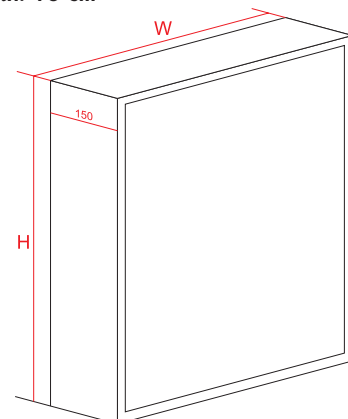

ASK ABOUT
PRODUCT



BASIC ELEMENTS OF EQUIPMENT

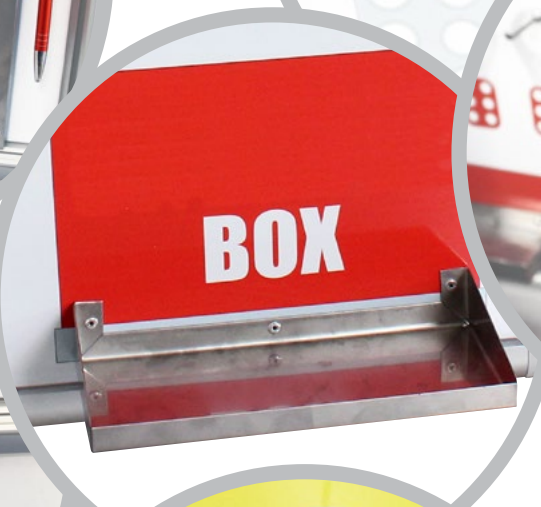

- Metal and plastic hooks
- Angle bracket for padlocks (1-3 padlocks per bracket)
- Document boards with a clamping mechanism
- Mounting of pens and markers
- Pockets for tags
- Screw-on shelves

Aluminium profile
EN AW-6060/6063



Stainless steel
304

ASK ABOUT
PRODUCT



Fixing elements
and hooks
galvanized steel
DIN 3570

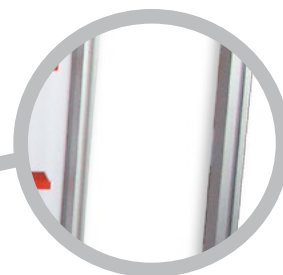

Plexiglas
(acrylic glass)



DIBOND - aluminium composite sheet,
comprising two 0.3 mm thick aluminium
cover layers and a polyethylene core

Aluminium profile
EN AW-6060/6063

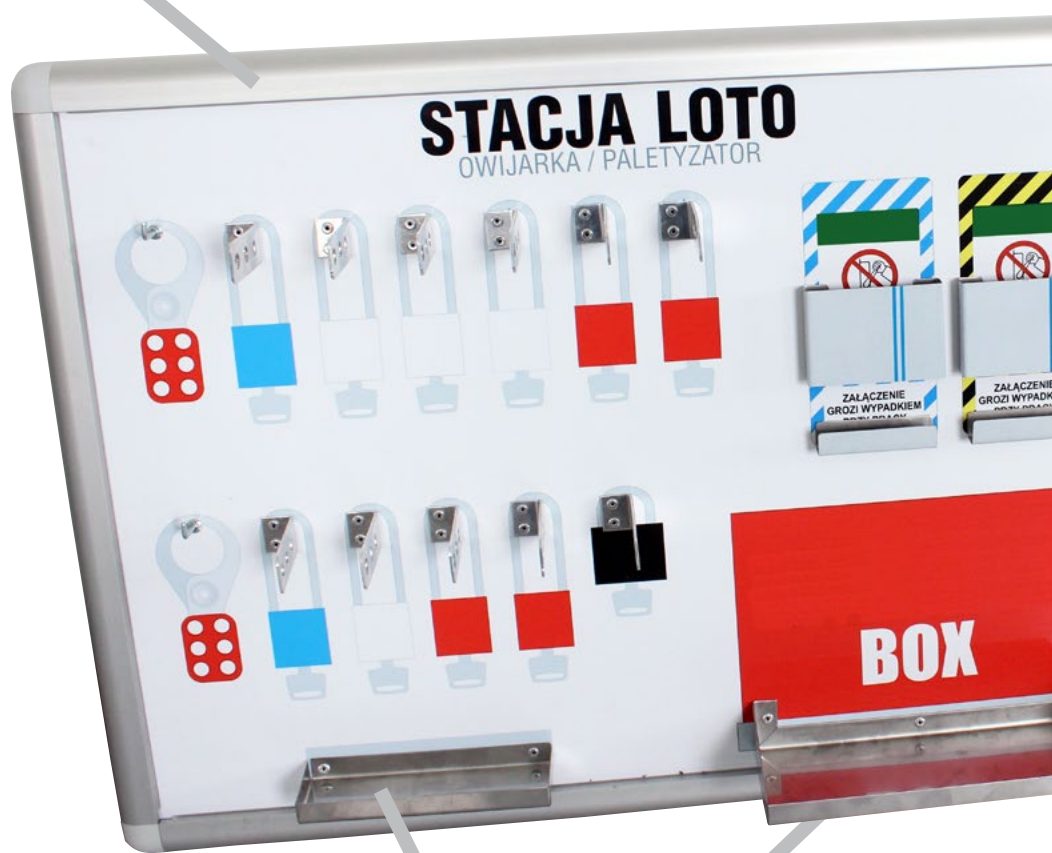

Stainless steel
304



ASK ABOUT
PRODUCT

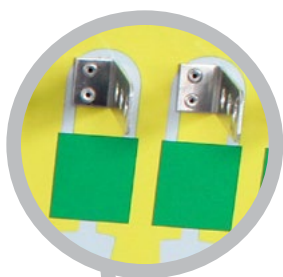

Fixing elements
and hooks
galvanized steel
DIN 3570

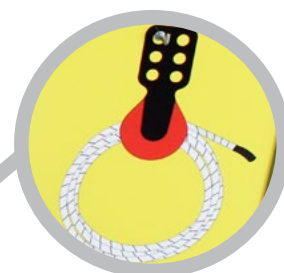

Print on dibond

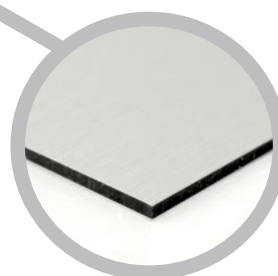

DIBOND - aluminium
composite sheet, comprising
two 0.3 mm thick aluminium
cover layers and a
polyethylene core.